

sunlite®

INSTALLATION INSTRUCTIONS

LED WALL SCONCE FIXTURE | 85099-SU LFX/WS/12W/LT/BN/10"

Please read and understand this entire manual before attempting to assemble, operate or install the product.

WARNING: Avoid fire or electric shock. Follow installation instructions carefully. If unsure about electrical installation, consult a qualified electrician. Wear rubber-soled shoes and work on a sturdy wooden ladder. Ground fixture to avoid potential electric shock. Handle metal parts carefully to prevent cuts. To avoid a hazard to children, account for all parts and destroy all packing materials.

This device complies with part 15 of the FCC rules. Operation is subject to the following two conditions: (1) This device may not cause harmful interference, and (2) this device must accept any interference received, including interference that may cause undesired operation.

CAUTION: Turn off the power at fuse or circuit breaker box before installation and maintenance. NOTE: This fixture is suitable for 120Volts fused circuit. Fixture must be installed according to National Electric Code and local building codes. If you are unsure about wiring, consult a qualified electrician. Suitable for wet Locations.

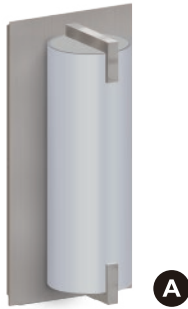

Introduction



Part	Item Name
A	LED WALL SCONCE FIXTURE
BB	Wire Nuts
CC	4X30MM Screws

Before beginning assembly and installation of product, make sure all parts are present. Compare parts with package contents list and diagram above. If any part is missing or damaged, do not attempt to assemble, install or operate the product. Contact customer service for replacement parts.

MIN 75°C SUPPLY CONDUCTOR

Installation

1. Disconnect electrical power before installing or servicing any part of fixture.
2. Remove mounting bracket from the canopy by unscrewing the mounting screws.
3. Wiring

Note: Most dwellings built before 1985 have supply wire rated to 60°C. Consult a qualified electrician before installing. This unit will not operate properly unless connected to a "grounded" electrical circuit. Electrical shock, over heating, low or no light output, and shortened LED life can result if proper grounding is not done.

Wire connection: Connect white (neutral) supply wire to white to white fixture wire; connect black (hot) supply wire to black fixture wire, connect ground wire to copper wire, using wire nuts provided. Pull on each wire lead to verify all connections are secure. Make sure no bare wires are exposed outside of the wire nuts.

4. Adjust CCT switch according to the desired color temperature as shown FIG.2.
5. Tuck all connections neatly into junction box. Attach the mounting bracket to the outlet box by tightening mounting screws A.
6. Install the canopy by sliding the slots in the canopy over the mounting screws B in the channel and tightening the two screws B.
7. Turn on power, confirm unit is operating properly.

FIG.1

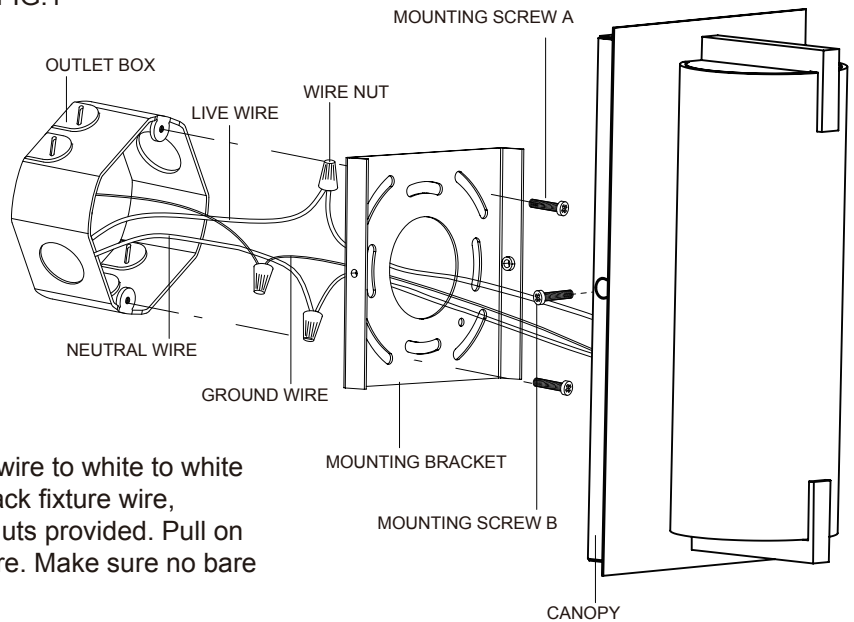
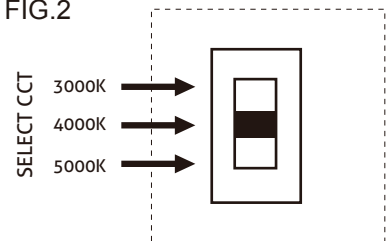

FIG.2



Sunshine Lighting Company

744 Clinton Street Brooklyn, NY 11231, USA
 T. 718.768.7000
 F. 718.768.0970
 www.sunlite.com